

Cavity metal fixing HM

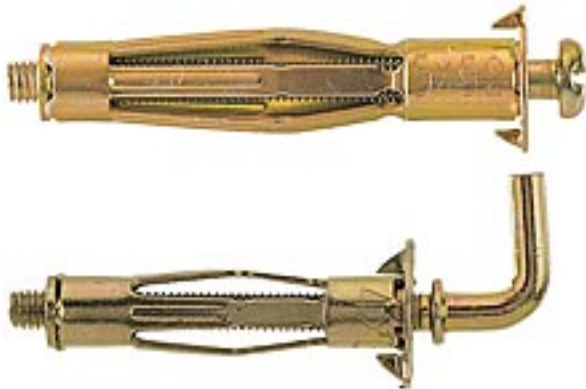

Usage

Suitable for:

- Gypsum plasterboard and gypsum fibreboards
- Chip boards

For fixing of:

- Pictures
- Lamps
- Skirting
- Electric switches
- Key boxes
- Small wall-mounted shelves
- Towel rails
- Lightweight mirror cabinets
- Curtain rails

Description

- Zinc-plated cavity metal fixing with metric screw.
- The expanding arms spread out behind the board and press against a large surface.

Examples of use



Installation

Type of installation

- Flush installation

Installation tips

- Observe the exact stated drill diameter.
- When using a battery-operated or normal screwdriver for installation, it is essential to use the item being attached as an anti-rotation lock.
- HM 8x55 SS must only be installed using the HM Z1 professional installation tool.

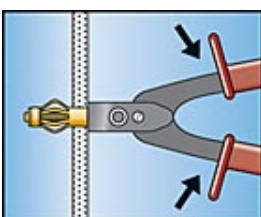
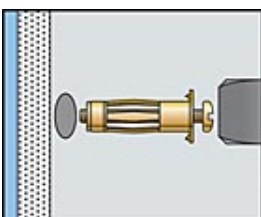
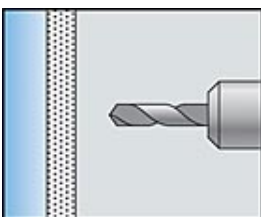

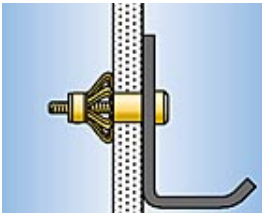
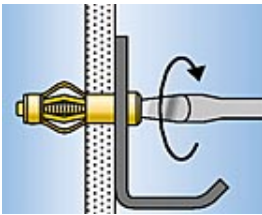
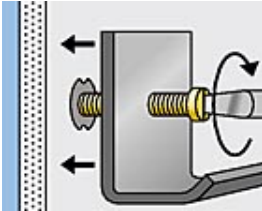
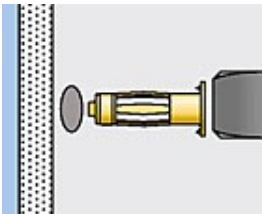
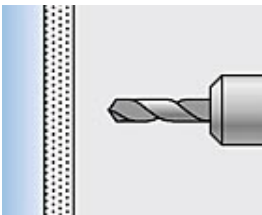
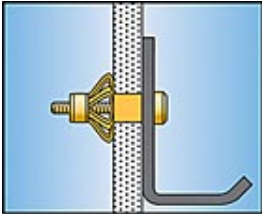
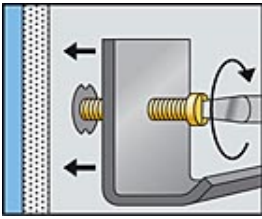

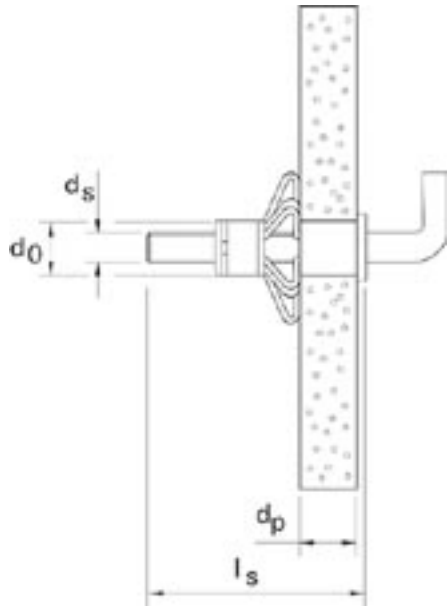

Technical data



Type	Art.-No.	ETA ■ DIBt ●	drill d_0 [mm]	min. drill hole depth t [mm]	anchor length l [mm]	screw $d_s \times l_s$ [mm]	max. panel thickness d_p [mm]	max. fixture thickness t_{fix} [mm]	angle hook $d_s \times l_s$ [mm]	
HM 4 x 32 S	62306	-	8,0	42	32	M 4 x 40	3 - 13	16	-	73181900
HM 4 x 46 S	62307	-	8,0	56	46	M 4 x 52	5 - 18	23	-	73181900
HM 4 x 59 S	62308	-	8,0	69	59	M 4 x 66	35 - 42	16	-	73181900
HM 5 x 37 S	62310	-	10	47	37	M 5 x 45	6 - 15	19	-	73181900
HM 5 x 52 S	62311	-	10	62	52	M 5 x 60	7 - 21	24	-	73181900
HM 5 x 65 S	62312	-	10	75	65	M 5 x 73	20 - 34	24	-	73181900
HM 6 x 37 S	62314	-	12	47	37	M 6 x 45	6 - 15	14	-	73181900
HM 6 x 52 S	62315	-	12	62	52	M 6 x 60	10 - 21	24	-	73181900

Type	Art.-No.	ETA  DIBt 	drill d_o [mm]	min. drill hole depth t [mm]	anchor length l [mm]	screw $d_s \times l_s$ [mm]	max. panel thickness d_p [mm]	max. fixture thickness t_{fix} [mm]	angle hook $d_s \times l_s$ [mm]	
HM 6 x 65 S	62328	-	12	75	65	M 6 x 70	20 - 34	24	-	73181900
HM 6 x 80 S	62316	-	12	90	80	M 6 x 88	38 - 50	24	-	73181900
HM 8 x 55 SS	62329	-	12	65	55	M 8 x 60	10 - 21	24	-	73181900
HM 4 x 32 H	62318	-	8,0	42	32	-	3 - 13	-	4 x 40	73181900
HM 5 x 65 H	62326	-	10	75	65	-	20 - 34	-	5 x 70	73181900
HM Z 1	62320	-	-	-	-	-	-	-	-	82032090
HM Z 2	62321	-	-	-	-	-	-	-	-	82032090